

NOTE: USE THERMOPLASTIC PAINT

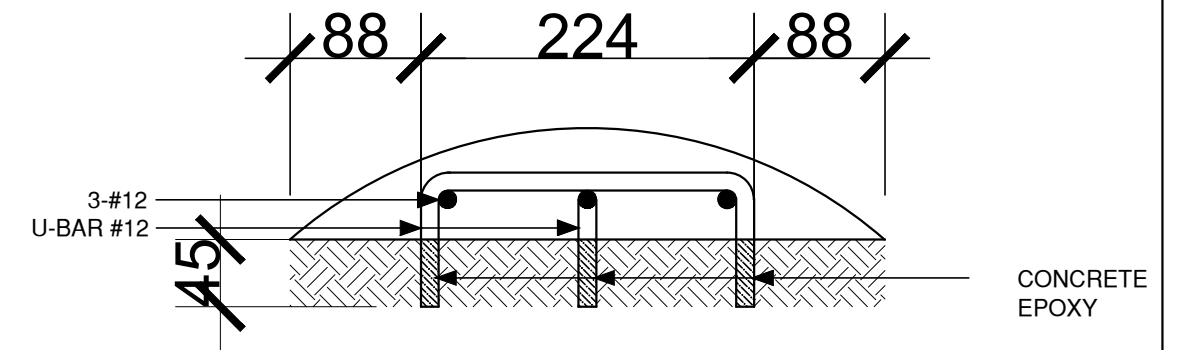

SECTION DETAILS

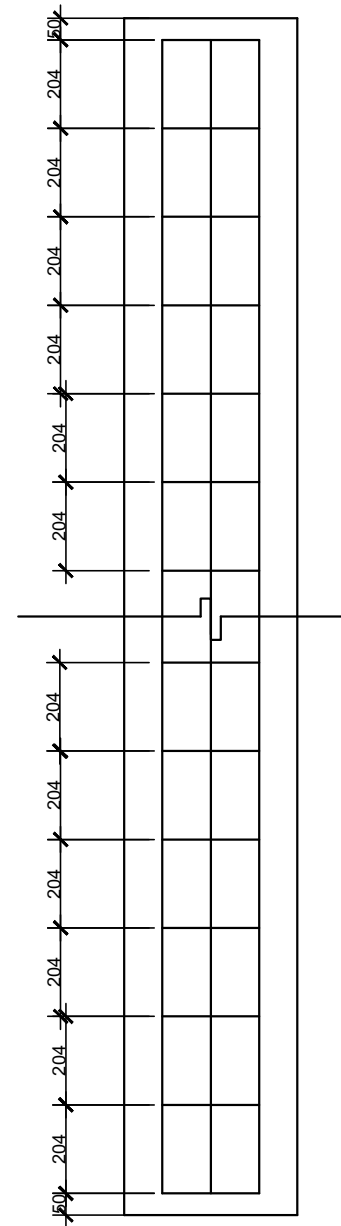
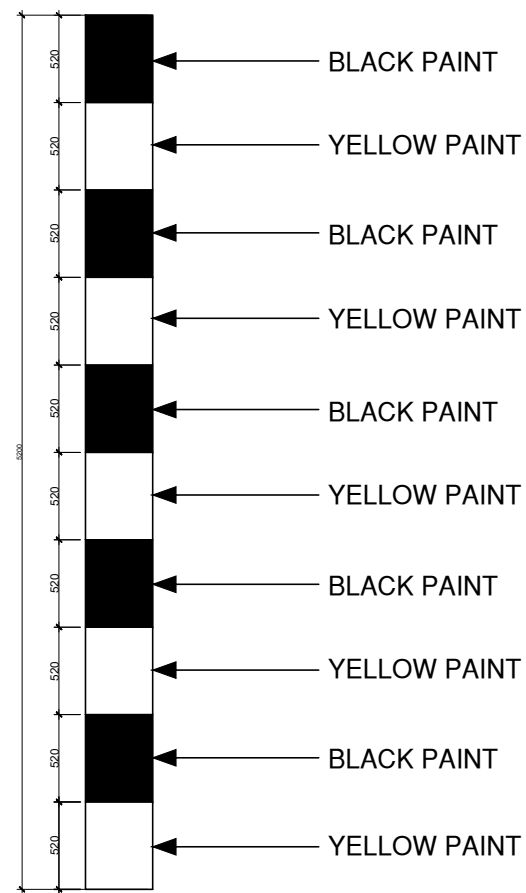
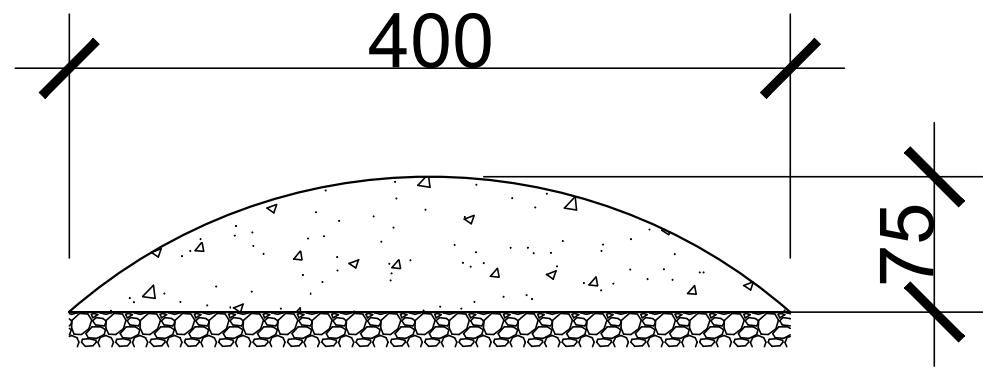

SPEED HUMPS PLAN

SCALE: NTS

SPEED HUMPS REINFORCEMENT DETAILS

SCALE: NTS

BLOW UP 1"

SCALE: NTS

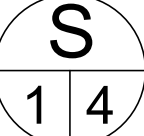
 REPUBLIC OF THE PHILIPPINES PHILIPPINE STATISTICS AUTHORITY	PROJECT DESCRIPTION: PROPOSED STANDARD TRAFFIC CONTROL PLAN OF PHILIPPINE STATISTICS AUTHORITY LOCATION: PSA Complex East Avenue, Quezon City	PREPARED BY: (signed) JODHAN T. COROS ENGINEER II MEMBER, BCOM-TWG	NOTED BY: (signed) BERNIE G. TUDIO ARCHITECT II MEMBER, BCOM-TWG	RECOMMENDING APPROVAL: (signed) REVELYN C. CAYETANO - ABDULAHIM ATTORNEY IV OIC DIVISION CHIEF-GSD	APPROVED BY: (signed) SOCRATES L. RAMORES HEAD, BUILDING COMMITTEE	APPROVED BY: (signed) REYNOR R. IMPERIAL CO-HEAD, BUILDING COMMITTEE	APPROVED BY: (signed) ATTY. MAQTAHAR L. MANULON, CESO V DIRECTOR II-OIC CIVIL REGISTRATION AND CENTRAL SUPPORT OFFICE	

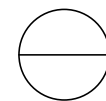
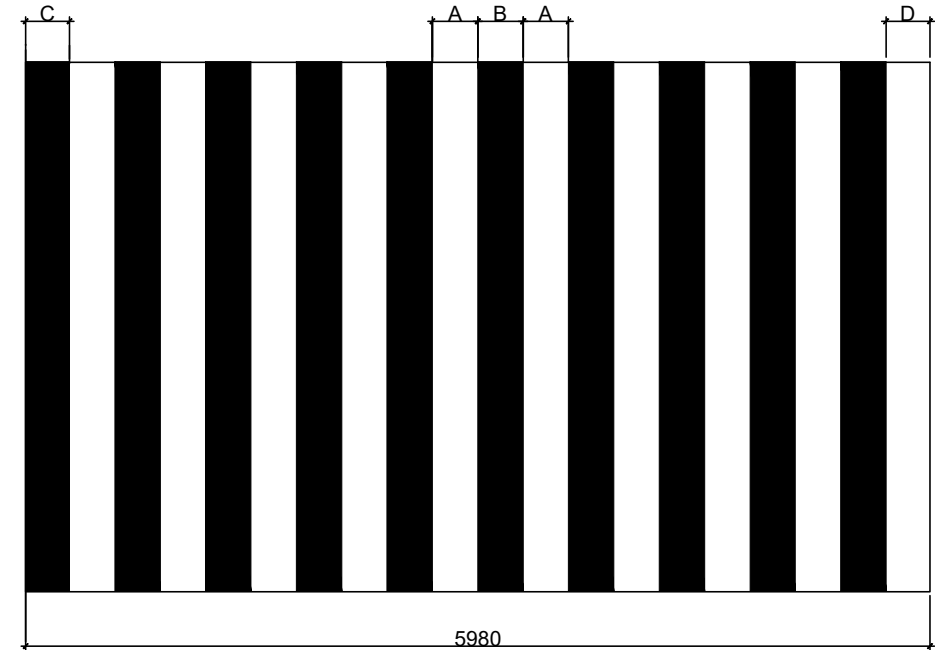
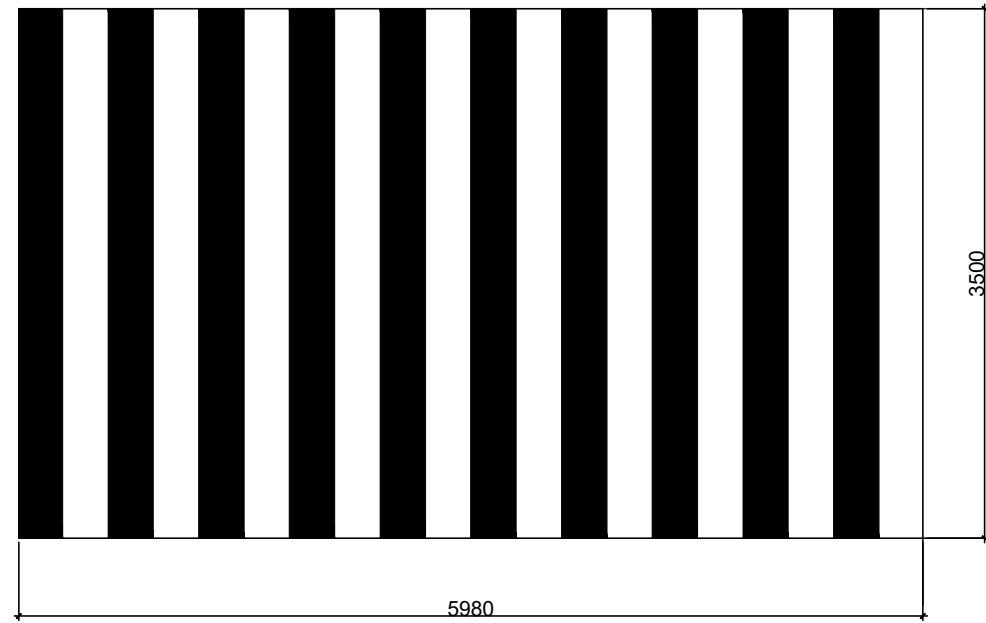

PEDESTRIAN CROSSING ZEBRA TYPE

SCALE: 1:50 M

CATEGORY	MEASUREMENTS	PAINT COLOR
A	300	WHITE
B	300	BLACK
C	290	BLACK
D	290	WHITE

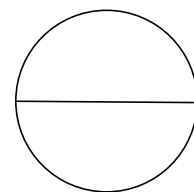

BLOW UP 2"

SCALE: NTS

NOTE: USE THERMOPLASTIC PAINT

 REPUBLIC OF THE PHILIPPINES PHILIPPINE STATISTICS AUTHORITY	PROJECT DESCRIPTION: PROPOSED STANDARD TRAFFIC CONTROL PLAN OF PHILIPPINE STATISTICS AUTHORITY LOCATION: PSA Complex East Avenue, Quezon City	PREPARED BY: (signed) JODHAN T. COROS ENGINEER II MEMBER, BCOM-TWG	(signed) BERNIE G. TUDIO ARCHITECT II MEMBER, BCOM-TWG	NOTED BY: (signed) REVELYN C. CAYETANO - ABDULAHIM ATTORNEY IV OIC DIVISION CHIEF-GSD	RECOMMENDING APPROVAL: (signed) SOCRATES L. RAMORES HEAD, BUILDING COMMITTEE	(signed) REYNOR R. IMPERIAL CO-HEAD, BUILDING COMMITTEE	APPROVED BY: (signed) ATTY. MAQTAHAR L. MANULON, CESO V DIRECTOR II-OIC CIVIL REGISTRATION AND CENTRAL SUPPORT OFFICE	